

## ADDENDUM TO OWNER'S MANUAL FOR V3 WITH WALNUT STOCKS:

The firearm disclosed in this addendum and components thereof may be subject to one or more pending patent applications.

The Remington V3 with walnut stocks is equipped with gas exhaust tubes that replace the gas compensating plugs as shown in the owner's manual.

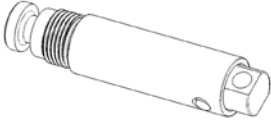

### GAS COMPENSATING PLUG

(Used with synthetic stocks and **vented** gas blocks)



### GAS EXHAUST TUBE

(Used with walnut stocks and **unvented** gas blocks)

**DISASSEMBLY:** (This information replaces step 8 in the *To Remove the Gas Pistons* section of the owner's manual on page 17.) To remove the gas pistons on V3's with walnut stocks for service or cleaning, remove the gas exhaust tubes using a  $\frac{3}{8}$ " open-end wrench turning counter-clockwise. (Pictures 19A and 25A, replace Pictures 19 and 25, respectively, in the owner's manual on pages 17 (disassembly instructions) and 18 (cleaning the barrel) of the owner's manual.)

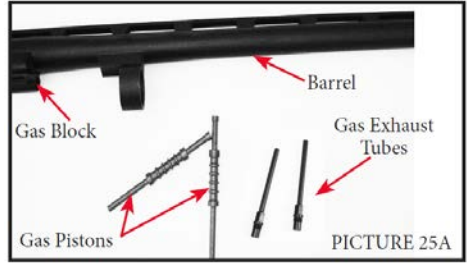

**REASSEMBLY:** (This information replaces steps 1-2 in the *To Reassemble the Gas Block* section of the owner's manual on page 21.) To reassemble the gas block, insert the gas pistons, small end first, into the top of the gas cylinders. Secure each gas piston by inserting the gas exhaust tubes in the top of the gas block cylinders. Tighten by turning clockwise. Torque to 30 in-lb or, if a torque wrench is unavailable, tighten by hand and using a  $\frac{3}{8}$ " open-end wrench, give a quick and firm pull on the tool to securely tighten the tubes.

**NOTE:** V3's with walnut stocks are also equipped with an **unvented** gas block (Picture A) on the barrel assembly. Gas exhaust tubes should only be used with **unvented** gas blocks. Using gas exhaust tubes on **vented** gas blocks (Picture B) can damage the fore-end.

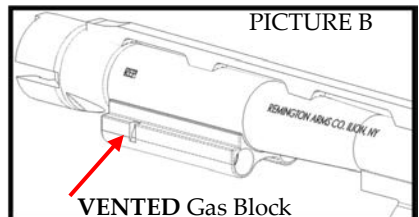
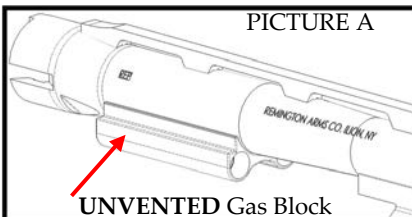

# Owner's Manual

Instruction Book for:  
Remington® V3™  
Autoloading Shotguns

## IMPORTANT!



This manual contains operating, care, and maintenance instructions. To ensure safe operation, any user of this firearm must read and understand this manual before using the firearm. Failure to follow the instructions and heed the warnings in this manual can cause property damage, personal injury, and/or death.

This manual should always accompany this firearm, and be transferred with it upon change of ownership.

**WARNING!** Keep this firearm out of the reach of children, unauthorized individuals, and others unfamiliar with safe handling of firearms.



### Alert Symbols and Definitions:

**WARNING!**

Indicates a hazardous situation which, if not avoided, will result property damage, personal injury or death.

**CAUTION!**

Indicates a hazardous situation which, if not avoided, could result minor to moderate personal injury.

**NOTE:**

Address practices not related to personal injury.

# Remington®

Page 2 .....	The Ten Commandments of Firearm Safety
Page 7 .....	Important Parts of the Firearm
Page 10 .....	To Check Barrel for Obstructions
Page 11 .....	To Assemble the Firearm
Page 11 .....	To Load the Firearm
Page 14 .....	To Unload the Firearm
Page 16 .....	Lubrication and Maintenance
Page 21 .....	To Function Test the Firearm
Page 27 .....	Parts List
Page 30 .....	How to Obtain Parts and Service

© 2016 Remington Arms Company, LLC



## Remington®



# A Tradition of Performance and Safety.

In 1816 Eliphalet Remington was confident he could make a flintlock that was as good or better than any he could buy. His confidence was well-founded. The barrel he handcrafted set a new standard for firearm accuracy and spawned generations of products that have made Remington America's leading gunmaker. While performance and style are certainly hallmarks of Remington firearms, one factor ultimately drives their performance. Safety. Eliphalet Remington never lost sight of the fact that his rifles were potentially lethal and could kill someone if handled improperly. And after more than 200 years the same holds true for any firearm, including your new Remington.

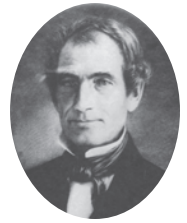

*Eliphalet Remington's first flintlock launched a proud tradition of accuracy & responsibility.*

## Safety is Critical to Performance.

A superbly crafted firearm is only as good as the hands that hold it. You can never be too careful. Shooting accidents are often caused by careless oversights such as failing to control the direction of the muzzle, failing to fully engage the safety, leaving ammunition in the chamber or using improper loads. These oversights can result in the destruction of life, limb or property. There's no calling back a bullet once it's been fired, so it's critical that you know the principles of safe firearm handling and storage before you ever take your new Remington firearm out of the box.

The proper use and performance of your firearm depends on correct assembly and maintenance, so it's critical that you familiarize yourself with the information in this instruction book. Even if you're a veteran shooter with a collection of Remington firearms, take the time to read this literature. Not all firearms are the same. That means the first step in safe handling is to learn the features and requirements of your new Remington.

## THE TEN COMMANDMENTS OF FIREARM SAFETY

The Ten Commandments of Firearm Safety should be etched in your memory forever. Let them govern your action wherever and whenever you're involved with firearms. In the field. On the range. Or in your home. Please take the time to review and understand these rules.

### 1st COMMANDMENT

**ALWAYS KEEP THE MUZZLE POINTED IN A SAFE DIRECTION.**

*This is the most important firearm safety rule.* A safe direction is one in which an accidental discharge will not cause injury to yourself or others. Never allow your firearm to point at anything you don't intend to shoot. Be especially careful when you're loading or unloading. Treat every firearm as if it were loaded. And make it a habit to know where the muzzle is pointed at all times, even when your firearm is unloaded. No one will be injured by an accidental discharge if you keep your firearm pointed in a safe direction. It is that simple.



### 2nd COMMANDMENT

**FIREARMS SHOULD BE UNLOADED WHEN NOT ACTUALLY IN USE.**

*Load your firearm only when you are in the field or on the target range and ready to discharge.* Never let a loaded firearm out of your sight or out of your hands. Unload it as soon as you are finished shooting before you bring it into your car, camp or home. Remember, unloading your firearm means unloading it completely, so there is no ammunition in the chamber or in the magazine. Before handling a firearm or passing it to someone else, visually check the chamber, receiver and magazine to be certain they do not contain ammunition. Always keep the firearm's action open when not in use. Never assume a firearm is unloaded even if you were the last person to use it. Always check for yourself.

- *Let common sense rule when you carry a loaded firearm.* If you are in a situation that could risk accidental discharge - such as crossing a fence, wading through a stream or climbing a tree - always unload your firearm. Never pull or push a loaded firearm toward yourself or another person. Never carry a loaded firearm in a scabbard, detached holster or firearm case.



*Firearms should be stored in a secure place where children cannot access them. A firearm safe is an ideal way to secure your firearm*

- *Certain firearms (including some Remington rifles and shotguns) are equipped with internal security devices to prevent unauthorized use.* Some firearms owners use external devices, such as cable locks and trigger blocks, for the same purpose. Even if you use such a device, you should still keep your firearm unloaded when stored or not in use. Using internal or external devices cannot substitute, however, for securing your firearms and ammunition in separate, locked locations.

- *Safe storage of firearms is just as critical as safe handling.* Never store firearms loaded. Be sure to keep your firearms in a secure place where unauthorized persons cannot get their hands on them without your knowledge.

- *Take special care if there are children around.* Children are fascinated by firearms. It is a natural curiosity that can have tragic consequences when not properly supervised. Store your firearms in a locked firearm safe or some other location that physically bars a child from gaining access.

- *Ammunition should be stored and locked in a location separate from your firearm.* Never leave an unsecured firearm or ammunition in a closet, dresser drawer or under the bed. Remember, it is your responsibility to make sure that children and others unfamiliar with firearms cannot get access to your firearm and ammunition.

### **3rd COMMANDMENT** **DO NOT RELY ON YOUR FIREARM'S SAFETY.**

*Treat every firearm as if it can discharge at any time, whether or not there is pressure on the trigger.* Your firearm has been carefully designed to maximize performance and safety. However, because a firearm's safety is a mechanical device, it could fail.

*Human error is a more likely reason for a firearm safety to fail.* By mistake, you may think the safety is on when it really is not. Or the safety may have been disengaged without your knowledge. Or you could think your firearm is unloaded when there is actually a cartridge or shell in it. A mechanical safety is not a substitute for common sense. It is merely a supplement to your proper handling of a firearm.

*Never touch the trigger on a firearm until you are ready to shoot.* Keep your fingers away from the trigger when you're loading or unloading. Do not pull the trigger when the safety is engaged or positioned between safe and discharge.

*Before using your firearm, read this instruction book to understand the exact location and operation of your firearm's safety.* Even when the safety is on, maintain control of your loaded firearm and control the direction of the muzzle. In other words, do not rely on your safety to justify careless handling. If your firearm's internal mechanisms are broken or have been altered, your firearm may discharge even when the safety is on. Remember, you and your safe firearm handling practices are your firearm's best safety.

### **4th COMMANDMENT** **BE SURE OF YOUR TARGET AND WHAT'S BEYOND IT.**

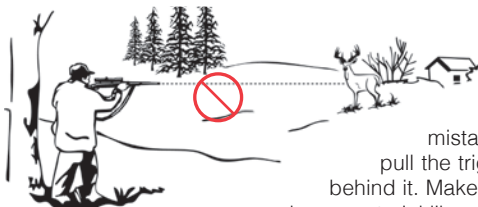

*You can not stop a shot in mid-air, so never discharge unless you know exactly where your shot is going and what it will strike.* Never discharge at a sound, a movement or a patch of color. A hunter in camouflage can easily be mistaken for a target by an impulsive shooter. Before you pull the trigger, be absolutely sure of your target and what is behind it. Make sure the shot has a backstop such as a hillside or dense material like sand. Remember, bullets can travel great distances with tremendous velocity. Know how far your shot will go if you miss your target or the bullet ricochets.

## **5th COMMANDMENT** **USE PROPER AMMUNITION.**

*Every firearm is designed to use a certain caliber or gauge of ammunition. Using the wrong ammunition, mixing ammunition or using improperly reloaded ammunition can cause serious personal injury or death. And it only takes one cartridge or shotshell of the incorrect caliber or gauge, or which has been improperly reloaded, to destroy your firearm.*

*It is your responsibility to make sure the ammunition you use exactly matches the caliber or gauge of your firearm. Refer to this instruction book to find out the specific requirements of your firearm. Always read and heed the instructions on ammunition boxes.*

*Confusing shells or cartridges can cause serious personal injury or death and destroy your firearm. Examine your shells or cartridges closely and use only the precise caliber or gauge for your specific firearm. For example, suppose you accidentally loaded a 20 ga. shell into a 12 ga. shotgun. Because the 20 ga. shell is too small for the chamber, the 20 ga. shell could travel down the barrel and get lodged in the bore. If you then loaded a standard 12 ga. shell behind it and fired, the 12 ga. shot will slam into the lodged 20 ga. shell and may cause the barrel to explode right in your hand. This is commonly called a 12/20 burst, and it can kill you.*

*Check all ammunition before you load it to make sure it matches your firearm's requirements. Every Remington cartridge and shell is head-stamped with its caliber or gauge for easy identification. Likewise, you'll find the caliber or gauge of your new Remington firearm imprinted on the barrel.*

### **Reloading Requires Extra Diligence**

If you reload ammunition, then you are responsible for ensuring that the components you use and the performance of your loads meets SAAMI guidelines for safety and performance – the same guidelines your firearm was tested to at the factory. Never use ammunition which has been reloaded by someone else. Reloading requires a thorough knowledge of reloading procedures and a deep respect for the explosive potential of gunpowder. Reloading incorrectly, whether by deviating from load specifications established by powder or component manufacturer's recommendations or exceeding 'maximum loads' could result in severe injury to yourself or bystanders or severe damage to your firearm. Dangerously high pressure can result from an overcharge of powder or other deviations from established reloading guidelines creating the potential for severe damage to your firearm and possible personal injury and/or death to you and/or bystanders. If you chose to reload, be extremely careful.

## **6th COMMANDMENT** **IF YOUR FIREARM FAILS TO DISCHARGE WHEN THE TRIGGER IS PULLED, HANDLE WITH CARE.**

*If for some reason the ammunition does not discharge when you pull the trigger, stop and remember the 1st Commandment of Firearm Safety - always keep the muzzle pointed in a safe direction. Keep your face away from the breech, then place the safety on, carefully open the action, unload the firearm and dispose of the cartridge safely. Remember that anytime there is a shell in the chamber, your firearm is loaded and ready to use. Even if you tried to shoot and your firearm did not discharge, treat your firearm as if it could still discharge.*

## **7th COMMANDMENT** **ALWAYS WEAR EYE AND EAR PROTECTION WHEN SHOOTING.**

*Your sight and hearing risk injury from shooting and should be protected at all times. Wear protective shooting glasses to guard against falling shot, clay target chips, powder residue, ruptured cartridge cases and even twigs and branches in the field. Also be sure to wear eye protection when you are disassembling or cleaning a firearm so that tensioned parts (like springs) and cleaning solvents do not come in contact with your eyes. Continued exposure to shooting noise can permanently damage your hearing. On the range, where shooting volume is the loudest, be sure to use the maximum protection of a headset. Learn to use ear protection at all times.*



## 8th COMMANDMENT BE SURE THE BARREL IS CLEAR OF OBSTRUCTIONS BEFORE SHOOTING.

*Before loading your firearm, open the action and make sure there is no ammunition in the chamber or magazine. Check the barrel for any obstructions or debris. Even a small amount of snow, mud, excess lubricant or grease in the bore can dangerously increase pressure and cause the barrel to bulge or burst when firing. Use a cleaning rod and patch to wipe away anti-rust compounds or any other residues or obstructions in the barrel. Never try to shoot out an obstruction by loading another shell and firing!*

*When firing, rely on your instincts. If the noise or recoil of your firearm seems weak, stop everything, unload your firearm and be sure nothing is lodged in the barrel. Remember the 12/20 burst? That is what can happen when the barrel is obstructed. Always be sure you're using the correct ammunition in your firearm and that it is free of obstructions.*

## 9th COMMANDMENT DO NOT ALTER OR MODIFY YOUR FIREARM AND HAVE IT SERVICED REGULARLY.

*Your firearm has been designed to operate according to certain factory specifications. You'll jeopardize your safety and that of others around you by attempting to alter its trigger, mechanical safety or other mechanisms. So never alter or modify your firearm in any way.*



*Like any mechanical device, a firearm is subject to wear. It must be maintained and periodically serviced to assure optimum safety and performance. Only a qualified service facility should service, repair or modify your Remington firearm. Consult your instruction book for instructions on how to send your firearm to the factory or for the location of the nearest Remington authorized repair station.*

*Proper cleaning and lubrication are also important to firearm maintenance and are necessary to assure accuracy, safety and reliability. Before cleaning, always make sure that your firearm is completely unloaded. Always clean the barrel from the chamber end to the muzzle when possible.*

*Make it a practice to clean your bore every time you are going to shoot. Be sure to clean your entire firearm before and after long-term storage and no less than once a year. It is also important to clean your firearm whenever it has been exposed to adverse conditions such as rain, dirt, mud, snow, sleet or saltwater.*

*For safe and dependable operation of your firearm, all parts of your firearm must be properly cleaned and lubricated. Periodically inspect the internal workings of your firearm to be sure they are clean and free of rust, unwanted dirt and debris.*

*Use recommended lubricants on your firearm and do not over-lubricate. Excessive use of a non-recommended lubricant could adversely affect the function and safe operation of your firearm. Remember, you are responsible for the proper care and maintenance of your firearm. Failure to properly maintain your firearm cannot only damage or ruin your firearm, it can expose you and others to unnecessary risks of personal injury or death.*

**NOTE:** Remington has a wide range of firearm care products and resources for best results when cleaning your firearm; everything from solvents and lubricants to rods and patches. They are all available from your Remington dealer.

## 10th COMMANDMENT

### LEARN THE MECHANICS AND HANDLING CHARACTERISTICS OF YOUR FIREARM.

*Not all firearms are alike.* They have different mechanical characteristics that dictate how you should carry and handle them. Anyone who plans to use a firearm should first become totally familiar with the type of firearm it is and the safe handling procedures for loading, unloading, carrying, shooting and storing it.

*Before you even unpack your new Remington firearm, read this instruction book from cover to cover and familiarize yourself with the different component parts of the firearm.* Then read, understand and follow *The Ten Commandments of Firearm Safety* in this manual.

**WARNING!** Discharging firearms in poorly ventilated areas, cleaning firearms or handling ammunition may result in exposure to lead, a substance known to cause birth defects, reproductive harm, cancer and other serious physical injury. Have adequate ventilation at all times. Wash hands thoroughly after exposure.



### SHOOT SOBER!!

There is one other rule that must be followed when handling firearms. In fact, respect for this rule is necessary in order to effectively practice *The Ten Commandments of Firearm Safety*. The rule is: SHOOT SOBER! Firearms and alcohol or drugs make a deadly combination. Never consume anything that would even mildly impair your judgment or physical coordination when you are using a firearm. A staggering percentage of the shooting accidents that occur every year involve alcohol or drugs. Be smart. Always shoot sober and stay alive.

**WARNING!** Failure to follow any of these safety rules may cause personal injury or death to the shooter or bystander and damage to property. Do not use a firearm until you fully understand and practice the Ten Commandments of Firearm Safety. If you have any questions about the safe use of a Remington firearm, write to us at Remington Arms Company, LLC, Consumer Service, P.O. Box 700, Madison, NC 27025-0700, or call us at 1-800-243-9700.

### DON'T KEEP THIS TO YOURSELF.

Now that you are a firearm owner you have the obligation to help ensure that shooting sports are safe for everyone participants and bystanders alike. You can do that by practicing these principles of firearm safety and passing them on to others - especially new shooters. Set an example for beginners. Be a guide to their safe entry into the exciting world of shooting sports. Invest your time and patience for the love of the sport and for its future. After all, it is your love of the sport that led you to buy a new Remington.

Firearm ownership is a right and privilege. It's a right guaranteed in this nation's Constitution. It is a privilege, which carries with it a personal responsibility to use your firearm in a way which will ensure your safety and the safety of others. The preservation of this right and privilege depends on the personal commitment of you and your fellow shooters to the safe and responsible use of firearms. Let *The Ten Commandments of Firearm Safety* outlined in the manual guide you at all times. Teach and promote these rules whenever you can. Remember, firearm safety depends on you! That is the only way to really enjoy your new Remington firearm and to preserve sport shooting as we know it today.

# Remington V3 Autoloading Shotguns

*Congratulations on your choice of a Remington! With proper care, it should give you many years of dependable use and enjoyment. For best results, we recommend that you use Remington Ammunition, the ammunition used in factory testing your firearm against our rigorous function and performance standards.*

**PICTURE 1** This picture shows the main parts of the REMINGTON V3 Autoloading Shotgun. The picture will aid in understanding the instructions.

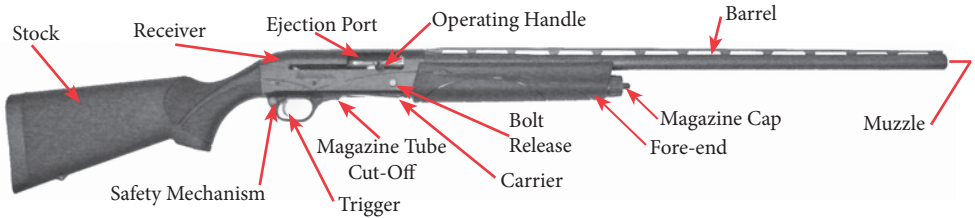

## Important Parts of the Firearm

### General Operation

The Remington V3 is a gas-operated, autoloading shotgun. The firearm is capable of firing successive shots with 2¾" and 3" inch shotshell cartridges interchangeably. At the start of the firing cycle the trigger is pulled and the hammer is released, striking the firing pin. In turn, the firing pin strikes the chambered shotshell's primer, igniting the powder charge. High pressure gas from behind the shot charge passes through ports in the barrel to the gas cylinders. The residual gas pressure forces the bolt assembly rearward, operating the action. The spent shell is extracted from the chamber. The hammer is re-cocked. The trigger and cartridge release are reset. As the action continues rearward the spent shell engages the ejector, expelling it from the receiver through the ejection port. When the bolt assembly is fully rearward, a new shotshell is released from the magazine onto the carrier. As the bolt assembly moves forward the carrier rises to place the new shell in front of the bolt assembly. Completing the cycle, the bolt assembly continues forward pushing the shell into the chamber. The bolt head rotates, locking the cartridge into battery (firing position). When the last shell has been discharged, the bolt assembly locks in the open position.

**NOTE:** Some illustrations in this manual may depict cosmetic differences not related to performance or safety.

### Serial Number and Cartridge Designation:

The serial number is located on the shooter's right side of the receiver. See Picture 2.

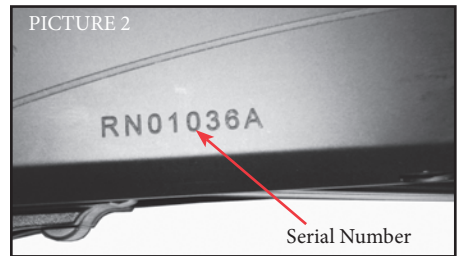

Specifications for the correct gauge and length of the shotshell intended for use in your shotgun is located on the shooter's left side of the barrel. See Picture 3.

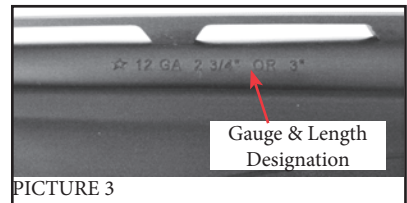

**WARNING!** Only use the specified gauge and length of shotshell ammunition specified for your shotgun as designated on the barrel. See "To Load the Firearm", on page 11. Using ammunition not specified for your firearm may lead to property damage, personal injury and/or death.

## The Safety Mechanism

The manual safety mechanism on the V3 shotgun provides protection against accidental or unintentional discharge under normal usage when properly engaged and in good working order.

This safety mechanism is not a substitute for following the rules of safe firearm handling. The cross bolt type safety prevents the trigger from being pulled when fully engaged in the "ON" or "Safe" position.

To engage the safety mechanism, push the "Safety Button," located at the rear of the trigger guard, to the shooter's right until the button stops and **THE RED BAND MARKING CANNOT BE SEEN**.

See Picture 4.

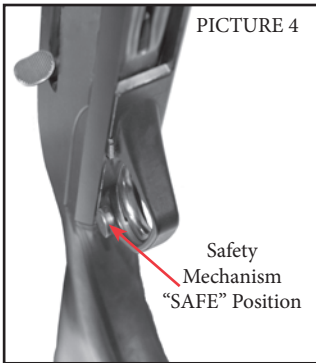

*Always engage the safety mechanism by moving the safety button to the shooter's right before handling, loading or unloading the firearm.*

*When you are ready to Fire the firearm, disengage the Safety Mechanism by pushing the Safety Button to the shooter's left until the button stops and the **RED BAND MARKING IS VISIBLE**. See Picture 5. You have now disengaged the Safety Mechanism and the firearm is ready to Fire.*

*Do not touch the trigger while moving the safety mechanism. Your fingers and all other objects should be kept outside of the trigger guard and away from the trigger until you are actually ready to Fire.*

*Never pull the trigger when the Safety Mechanism is in the "ON" or "Safe" position.*

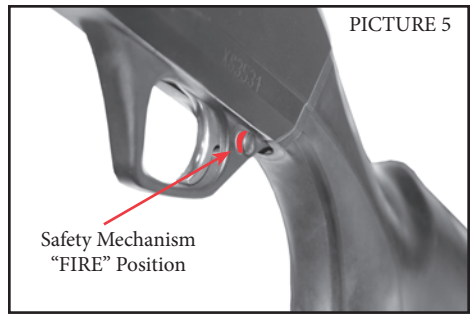

**WARNING!** The firearm will discharge when the trigger is pulled and the safety mechanism is OFF or in the "Fire" position. Failure to control the firearm at all times may lead to personal injury and/or death.

Even when the safety is engaged in the "ON" or "Safe" position, careless handling can cause the firearm to discharge. See The Third Commandment of Firearm Safety.

**NOTE:** If desired, a left-handed shooter may have the operation of the safety mechanism reversed by the factory or a Remington Authorized Repair Center. Once reversed to accommodate a left-handed shooter, the safety mechanism's "ON" and "OFF" positions will be exactly opposite as described in this manual.

## Additional Features:

Besides the manual safety mechanism, the V3 autoloading shotguns incorporate passive features providing additional protection against accidental or unintentional discharge under normal usage and in good working order. These passive features such as the inertia firing pin system, steel alloys and/or their metallurgical treatments, the hammer, sear, and trigger engagements, the trigger disconnect, the breech lock-up system, head space, and the trigger guard all work without direct input from the user as long as your firearm is kept clean and in good working order.

**WARNING!** Do not alter, modify, bypass, or render these safety features inoperative. Altering, bypassing, or rendering these features inoperative may lead to personal injury, property damage and/or death.

## The Locking Device

This firearm was originally sold with a key-operated locking device to assist the owner in protecting against unauthorized use. These are storage locking devices, which should be used when the firearm is stored or not in use. Always store a firearm completely unloaded.

**WARNING!** The locking device **DOES NOT** eliminate the need for safe firearm handling and storage, including keeping this and every firearm unloaded and locked in a secure place when not in use. Read and follow these and other safety rules in this instruction manual. Failure to read, understand, and obey these rules can result in serious personal injury or death. See *The Ten Commandments of Firearm Safety*, on page 2.

Keep your locking device engaged when your firearm is not in use. Keep the keys in a secure place, inaccessible to others. DO NOT leave your keys or any ammunition with your firearm, which should be kept locked in a safe place.

To secure your firearm with an external locking device, See instructions provided in the packaging.

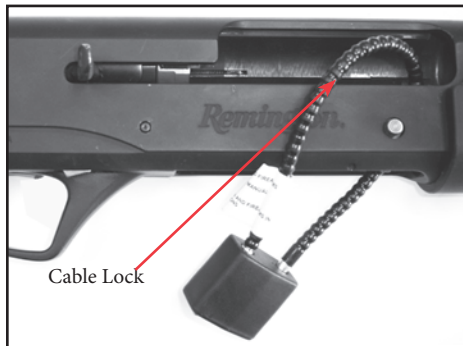

## The Operating Handle, Bolt Release

The operating handle is used to move the bolt rearward, opening the action. The bolt release is used to release the bolt from the locked open position. See Picture 6.

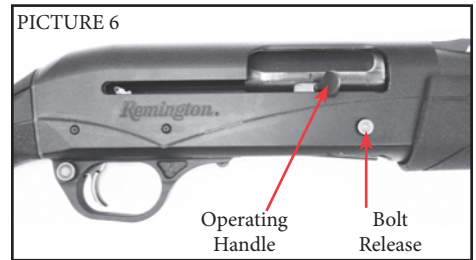

**WARNING!** When the operating handle (bolt assembly) is forward in the closed position and the safety mechanism is in the "OFF" or in the "Fire" position, the firearm can be discharged by pulling the trigger. Not controlling the firearm may lead to property damage, personal injury and/or death.

## The Trigger Assembly

**Pulling the trigger FIRES the firearm.**

The trigger assembly of your V3 shotgun is a single-action (SA) system. When the trigger is pulled fully rearward, it starts the firing sequence by releasing the hammer. The trigger assembly is not adjustable. All repairs to the trigger assembly must be made by the factory or a Remington Authorized Repair Center. See page 30 on how to obtain repairs and service.



**WARNING!** Never place your finger on the trigger unless you are ready to discharge or fire the firearm. An unintentional or uncontrolled discharge of your firearm may cause property damage, personal injury and/or death.

**WARNING!** Never manipulate, adjust or change any of the internal components of your firearm. Improper manipulation of any internal component may effect the safety and reliability of your firearm and may cause serious injury or death.

## The Choke Tube

The inside bore constriction at the muzzle end of a shotgun's barrel is known as the "Choke." When a shotshell is discharged, shot travels down the bore, exiting the muzzle and begins to "spread out." The spread of the shot is controlled by changing the muzzle constriction. The V3 has a changeable, screw-in, choke tube system. To change or replace the barrel's choke tube, see: "To Change the Choke Tube," on page 14. For more information about choke tubes, see: *The Remington Guide to Shotguns and Shotshell Ammunition* publication.

**WARNING!** Completely unload your shotgun chamber and magazine before removing or installing a choke tube and ensure the safety mechanism is engaged by placing the safety in the "ON" or "Safe" position. Changing a choke tube when the firearm is loaded or the safety is not in the "Safe" position may lead to personal injury and/or death.

**NOTE:** Never discharge your shotgun without a choke tube properly installed, as property damage may occur.

**NOTE:** Never discharge steel shot through a lead-only choke tube. Choke tubes NOT designated for steel will be marked "Lead Only."

## The Magazine Plug

A magazine plug is provided with your shotgun to limit the magazine capacity to two (2) shotshells. A limited magazine capacity limit is required by the Federal Migratory Bird regulations and certain state laws. Check with your local Fish & Game Commission or other appropriate authorities to determine whether a magazine plug is required to limit the magazine capacity within your jurisdiction.

To install or remove a magazine plug, See: "To Install the Magazine Plug," on page 15.

**WARNING!** Before installing or removing a magazine plug, make sure the firearm is completely unloaded chamber and magazine and the safety mechanism is engaged by placing the safety in the "ON" or "Safe" position. Changing the magazine plug when the firearm is loaded may lead to personal injury and/or death.

## The Barrel

**WARNING!** The inside of the barrel and chamber must be clean and free of obstructions. See the *The Ten Commandments of Firearm Safety*, on page 2. Discharging a firearm with a barrel obstruction may lead to property damage, personal injury and/or death.

### I. To Check the Barrel for Obstructions:

1. Always keep the firearm pointed in a safe direction.
2. Engage the safety mechanism in the "ON" or "Safe" position. The red band will NOT be visible.
3. Make sure that the magazine tube is empty. See Page 14
4. Open the bolt by pulling the operating handle fully rearward, locking the bolt in the open position.
5. Visually check the chamber, ejection port and magazine to make sure the firearm is completely unloaded.
6. Insert a cleaning rod into the muzzle.
7. Push the rod completely through the barrel until the rod can be seen at the ejection and loading port.

### II. To Remove a Barrel Obstruction:

**WARNING!** NEVER try to remove an object from the barrel by loading a shotshell (cartridge) and firing. This may cause the barrel to burst or a shotshell to rupture and cause serious personal injury and/or death.

1. Always keep the firearm pointed in a safe direction.
2. Engage the safety mechanism in the "ON" or "Safe" position. The red band will NOT be visible.
3. Make sure that the magazine tube is empty. See Page 14
4. Lock the bolt assembly open by pulling operating handle all the way to the rear of the receiver.
5. Visually check the chamber, ejection port, and magazine to make sure the shotgun is completely unloaded.
6. Remove the barrel. See "To Disassemble the Firearm for Cleaning," on Page 16.
7. Insert a cleaning rod of the correct bore size into the muzzle and lightly tap the rod to free object from the barrel.

- If an object cannot be easily pushed out the barrel with a cleaning rod, return the barrel to the factory or a Remington Authorized Repair Center. See page 30, To Obtain Parts and Service from Remington Arms Company, LLC.

### To Assemble the Firearm:

The firearm was shipped with the barrel assembly removed.

**CAUTION!** Always wear eye protection when handling, disassembling and reassembling the firearm. Not wearing eye protection may lead to personal injury.

**NOTE:** The bore and chamber should be cleaned before assembly. See “To Clean the Barrel,” on Page 18.

- Always keep the firearm pointed in a safe direction.
- Engage the safety mechanism in the “ON” or “Safe” position by moving the safety button fully to the shooter’s right. The red band will NOT be visible.
- Make sure that the magazine tube is empty. See Page 14
- Visually check the barrel making sure there are no obstructions.
- Unscrew and remove the magazine cap by turning it counterclockwise.
- Remove the fore-end from the magazine tube by sliding it forward.
- Open the bolt by pulling the operating handle rearward until the bolt locks in the open position. See Picture 7.



PICTURE 7

- If the bolt gets stuck in an intermediate position between its forward most and rearmost position apply light forward pressure to the operating handle and rearward pressure to the operating handle to release it from this intermediate position. Continue to pull the bolt handle rearward until it locks open.
- Insert the barrel into the receiver and the barrel ring over the magazine tube. See Picture 8.

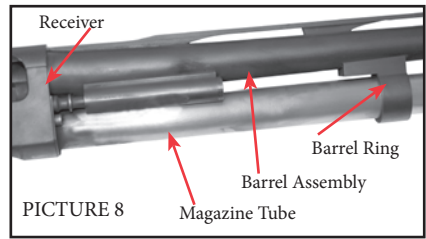

PICTURE 8

- Place the fore-end over the magazine tube until it seats against the receiver.
- Replace the magazine cap on the end of the magazine tube. Tighten by turning clockwise until hand-tight.

### To Load and Unload the Firearm To Load the Firearm:

**WARNING!** The specific gauge and lengths of shotshell ammunition suitable for use in your shotgun is marked on the barrel. DO NOT use any ammunition other than the designated gauge and lengths specified for your shotgun. Using incorrect ammunition in your firearm can result in a severe malfunction of your firearm or ammunition, leading to personal injury and/or death. See *The Ten Commandments of Firearm Safety*.

### Ammunition:

The V3 shotgun is designed to function with 2¾” and 3” inch ammunition. If you experience any initial cycling problems with certain loads, we recommend firing a number of shotshells of standard game loads to speed the break-in of your new shotgun.

Always check the cartridge for the correct gauge and length before loading the firearm. To find additional ammunition information, see the Remington catalog or visit the Remington website at [www.remington.com](http://www.remington.com).

Although this gun is designed to function with 1-oz target loads it is recommended for a new gun to start out with 1-1/8 oz loads and above during a brief break-in period for optimum performance.

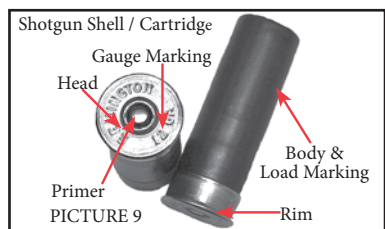

PICTURE 9

**WARNING!** Do not apply oil, grease, or any lubricants to shotshells. Not following these rules may lead to property damage, personal injury and/or death.

## To Fully Load the Firearm:

**WARNING!** Always check the shotshell for the correct designation before loading the firearm. Loading an incorrect shotshell may lead to property damage, personal injury and/or death.

**Note:** The bore should be cleaned before loading the firearm the first time. Follow the cleaning instructions shown on Page 18, "To Clean the Barrel."

1. Always keep the firearm pointed in a safe direction.
2. Engage the safety mechanism in the "ON" or "Safe" position by moving the safety button fully to the shooter's right. The red band will NOT be visible.
3. Pull the operating handle fully rearward to lock the bolt assembly in the open position.
4. With the bolt assembly locked open, visually check the chamber, ejection port, and magazine making sure the firearm is completely unloaded. If the chamber is not unloaded, see page 14, "To Unload the Firearm."
5. Make sure the barrel and chamber are free of obstructions, see page 10, "To Check the Barrel for Obstructions."

### I. To Load the Chamber:

6. Place one shell onto the carrier through the ejection port. See Picture 10.

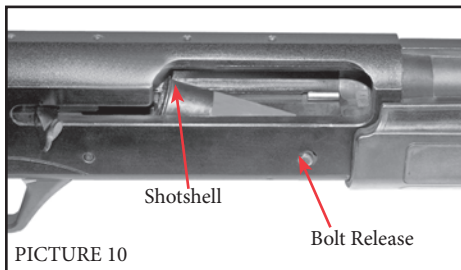

PICTURE 10

7. Close the bolt assembly fully by pressing the bolt release, chambering the shotshell.

**WARNING!** The shotgun is now cocked and loaded. Make sure the safety mechanism is still engaged in the "ON" or "Safe" position. Always keep the firearm pointed in a safe direction. Not controlling the muzzle of the firearm can lead to personal injury and/or death.

**CAUTION!** When releasing the bolt, keep hands, clothing and other objects away from the bolt and bolt handle. Personal injury may result.

### II. To Load the Magazine:

8. Push up to three (3) 2¾" or 3" shotshells of the correct gauge, one at a time, fully forward into the magazine tube (see Picture 11), ensuring the rim of each shell engages the feed latch and is held inside the magazine tube. See Picture 12.

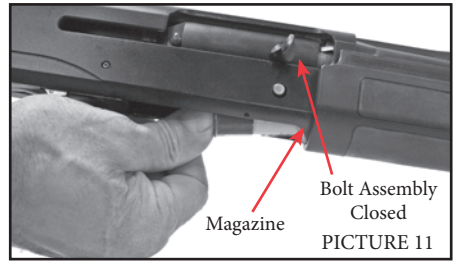

PICTURE 11

### To Load the Chamber From the Magazine:

**Note:** The bolt assembly must be fully forward and the hammer must be cocked before the magazine can be loaded.

1. Always keep the firearm pointed in a safe direction.
2. Engage the safety mechanism in the "ON" or "Safe" position by moving the safety button fully to the shooter's right. The red band will NOT be visible.
3. Pull the operating handle fully rearward to lock the bolt assembly in the open position.
4. With the bolt assembly locked open, visually check the chamber, ejection port, and magazine making sure the shotgun is completely unloaded.

5. Make sure the barrel and chamber are free of obstructions, see page 10, "To Check the Barrel for Obstructions."

**CAUTION!** When loading, keep hands, clothing and other objects away from the bolt and bolt handle. Personal injury may result.

6. Close the bolt assembly by pressing the Bolt Release. See Picture 10.
7. Push up to three (3) 2¾" or 3" shotshells of the correct gauge, one at a time, past feed latch into the magazine tube, ensuring the rim of each shell engages the feed latch and is held inside the magazine tube. See Picture 12.

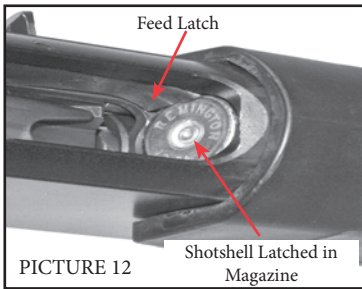

8. Pull the operating handle fully rearward to release a round from the magazine then release, chambering the staged round.

**WARNING!** The shotgun is now cocked and fully loaded. Make sure the safety mechanism is still engaged in the "ON" or "Safe" position. Always keep the firearm pointed in a safe direction. Not controlling the muzzle of the firearm can lead to personal injury and/or death.

### How to Change a Chambered Shotshell without Feeding a Shotshell from the Magazine (cut-off)

1. Always keep the firearm pointed in a safe direction.
2. Engage the safety mechanism in the "ON" or "Safe" position. The red band will NOT be visible.
3. Engage the magazine cut-off by sliding it forward until it stops. This action will lift the carrier slightly. See Picture 13.

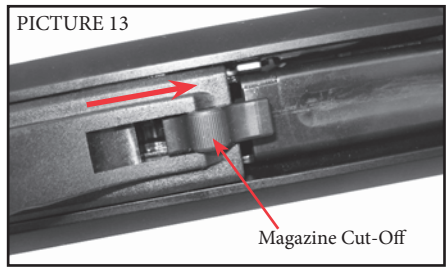

4. Pull the operating handle rearward, extracting and ejecting the chambered shotshell.
5. Drop a shotshell onto the carrier through the ejection port. See Picture 14.
6. Chamber (load) the staged shotshell by sliding the magazine cut-off rearward to release the bolt and lift the carrier.

**WARNING!** Before releasing the bolt make sure fingers, hands, and clothing are clear of the bolt's movement forward. Failure to follow these instruction could result in property damage, personal injury and/or death.

**NOTE:** The magazine cut-off can also be used any time it is necessary to unload the chamber without feeding a round from the magazine.

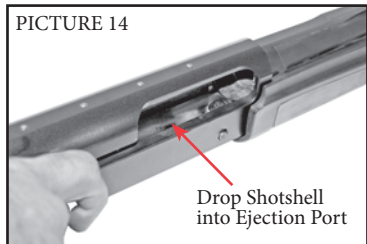

### To Discharge the Firearm:

**WARNING!** Not controlling the muzzle of the firearm can lead to personal injury and/or death.



**CAUTION!** Always wear eye and hearing protection when discharging your firearm. See *The Ten Commandments of Firearm Safety*, on page 2. Personal injury may result.

1. Point the muzzle at your intended target.
2. Disengage the safety mechanism by moving the safety button to the "OFF" or "Fire" position. The red band will be visible.

3. With target acquired and the butt of the shotgun firmly mounted against your shoulder, pull the trigger. The firearm will discharge each time the trigger is pulled until the magazine and chamber are empty. The bolt will remain open when the last shell has been discharged.

**WARNING!** If a shotshell does not discharge when the trigger is pulled (misfire), keep the firearm pointed in a safe direction and wait one minute before opening the bolt. See: "To Unload the Firearm", on page 14. Failure to control the firearm at all times may lead to personal injury and/or death.

**WARNING!** If the "report" of the shot is noticeably softer or louder or any way irregular, keep the firearm pointed in a safe direction; unload the firearm and check for bore obstructions. See: "To Remove a Barrel Obstruction", on page 10. Discharging a firearm with a barrel obstruction may lead to property damage, personal injury and/or death.

4. Engage the safety mechanism in the "ON" or "Safe" position by moving the safety button fully to the shooter's right. The red band will NOT be visible.
5. With the bolt locked open, visually check the chamber, loading port, and magazine to make sure the firearm is completely unloaded.

## To Unload the Firearm

**WARNING! NEVER assume your firearm is unloaded to justify careless handling. Always control the direction of the muzzle of your firearm, even if you think it is completely unloaded. Not following these rules may lead to personal injury and/or death.**

1. Always keep the firearm pointed in a safe direction throughout the unloading process.
2. Engage the safety mechanism in the "ON" or "Safe" position by moving the safety button fully to the shooter's right. The red band will NOT be visible.
3. Pull the operating handle fully rearward, extracting and ejecting the chambered cartridge.
4. Chamber (load) the staged shotshell by releasing the bolt.

5. Repeat steps 3 thru 5 until all shotshells are removed from the firearm. When all shotshells are removed from the firearm, the bolt will remain open in the locked position.
6. With the bolt locked open, visually check the chamber, ejection port, and magazine to make sure the firearm is completely unloaded and the barrel is free of obstructions.

## To Change the Choke Tube:

**WARNING!** Completely unload the firearm before changing the choke tube. See "To Unload the Firearm", page 14. Not unloading before changing a choke tube may lead to property damage, personal injury and/or death.

**Note:** Use only Rem Choke tubes in your firearm.

1. Always keep the firearm pointed in a safe direction.
2. Engage the safety mechanism in the "ON" or "Safe" position by moving the safety button fully to the shooter's right. The red band will NOT be visible. If the firearm is not unloaded, See "To Unload the Firearm," page 14.
3. Pull the operating handle fully rearward to lock the bolt in the open position.
4. With the bolt locked open, visually check the chamber, loading port, and magazine to make sure the firearm is completely unloaded.
5. Place the choke tube wrench supplied with your shotgun into the choke tube. See Picture 15.

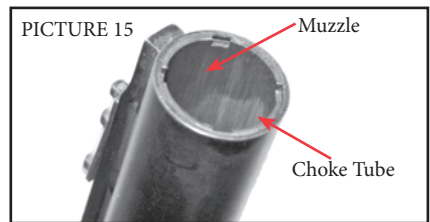

6. Turn the choke tube wrench counter-clockwise until the choke tube can be removed from the barrel.
7. Select the desired choke tube and insert it into the barrel muzzle.
8. Place the choke tube wrench onto choke tube and tighten by turning clockwise.

9. Remove choke tube wrench.
10. With the Safety in the "ON" or "Safe" position, bolt open, and the chamber and magazine completely unloaded, check the choke tube periodically to make sure it is tight and secure.

**NOTE:** Never discharge your shotgun without a choke tube properly installed, as property damage may occur.

### To Install the Magazine Plug:

**NOTE:** Check with you local Fish & Game Commission or other appropriate authorities to determine whether a magazine plug is required in your jurisdiction.

1. Always keep the firearm pointed in a safe direction.
2. Engage the safety mechanism in the "ON" or "Safe" position by moving the safety button fully to the shooter's right. The red band will NOT be visible.
3. Completely unload the chamber and magazine. See "To Unload the Firearm," on page 14.
4. With bolt locked open, visually recheck the chamber, loading port, and magazine, making sure the shotgun is completely unloaded.
5. Ensure the barrel and chamber are free of obstructions, see page 10, "To Check the Barrel for Obstructions."
6. Remove the magazine cap by turning it counterclockwise.

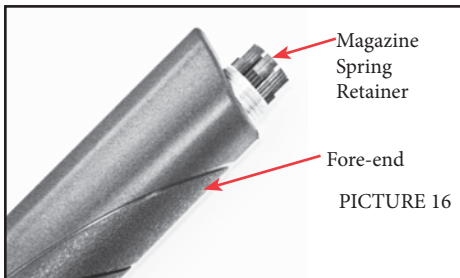

PICTURE 16

**CAUTION!** Use extreme care when removing the magazine spring retainer, as the magazine spring is under compression. Wear eye protection to avoid serious personal injury.

7. Depress magazine spring retainer until it stops, turn ¼ turn counterclockwise and slowly release magazine spring and retainer as it is under pres-

sure. Remove the magazine spring retainer. Do not remove the magazine spring.

**CAUTION!** Make sure to maintain control of magazine spring retainer until pressure from magazine spring is relieved. Personal injury may result.

8. With the magazine spring in the magazine tube, place the magazine plug into the center of the magazine spring.
9. Place the open end, (end without teeth) of the magazine spring retainer on top of magazine spring.
10. Push the magazine spring, plug, and retainer into the magazine tube while aligning the magazine spring retainer detent slots with the detents in the magazine tube. See Picture 17.

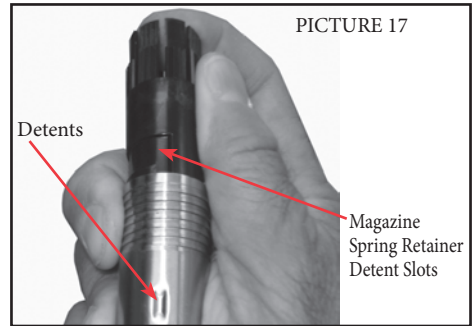

PICTURE 17

11. Once the detents are aligned, push the magazine spring, plug, and retainer down into the magazine tube (approximately 1½ inch) until the magazine retainer can be turned ¼ of a turn clockwise, locking the retainer in position.
12. Replace the magazine cap by turning clockwise until hand tight. Do not over-tighten.

### Sights:

**WARNING!** Before adjusting the sights or mounting any telescopic sights or other optics, make sure the firearm is completely unloaded and the safety mechanism is engaged by placing the safety in the "ON" or "SAFE" position. See "To Unload the Firearm", page 14. Not following these rules may lead to property damage, personal injury and/or death.

## Receiver Mounted Optics:

The top of the V3 receiver is drilled and tapped for an optic sight mount (not provided). For optic mounting and adjustment see the instructions provided with your optic sight system.

## Cleaning, Lubrication and Maintenance

**WARNING!** Before cleaning, make sure your firearm is completely unloaded (both the chamber and the magazine) and engage the safety by placing the safety mechanism in the "ON" or "Safe" position. Not following the rules for Safe firearms handling may lead to personal injury and/or death.

### Lubrication:

Over-lubrication should be avoided at all times. A light application of Rem® Oil helps to prevent rusting.

**WARNING!** Excessive use of a lubricant could adversely affect the function and safe operation of your firearm. Failure to properly maintain your firearm can not only damage your firearm, it can expose you and others to unnecessary risks of personal injury or death.

When the firearm is to be stored, it should be carefully cleaned and thoroughly oiled. Outside metal surfaces should be wiped with Rem Oil occasionally. When the firearm is to be reused, all excess lubrication must be removed. The chamber and bore must be thoroughly wiped dry.



For safe and dependable operation of your firearm, the barrel and action must be cleaned periodically.

Remington recommends using Remington cleaning products and lubricants or their equivalents.

**WARNING!** The use of a non-recommended lubricant or cleaner could adversely affect the function and safe operation of your firearm. Do not use congealing lubricants. The use of non-congealing lubricants such as Rem Oil is strongly recommended.

**NOTE:** Remington's Rem Oil is available from your local dealer. If your dealer is out of stock, ask the dealer to order Rem Oil from the Remington Distributor.

**WARNING!** After each use, follow the lubrication and maintenance directions in this Owner's Manual. If the firearm is immersed in water, it must be thoroughly cleaned and lubricated as soon as possible. In case of saltwater immersion, first flush all parts with fresh water, then dry, clean and lubricate the firearm. If the firearm does not function properly, have it checked and repaired by a Remington Authorized Repair Center before further use. Failure to follow these instructions may lead to firearm malfunctions which could result in serious personal injuries and/or death.

**NOTE:** The chamber and bore should be cleaned before loading and firing the firearm the first time.

## To Disassemble the Firearm for Cleaning:

**WARNING!** Completely unload the firearm before cleaning. Look into the ejection port and visually check the chamber and magazine to make sure there are no cartridges in the firearm.

**CAUTION!** Always wear eye protection when handling, disassembling and reassembling the firearm. Not wearing eye protection may lead to personal injury.

**NOTE:** The V3 firearm should NOT be disassembled beyond what is described in this manual, except by the factory or a Remington Authorized Repair Center.



PICTURE 18

## To Remove the Barrel:

1. Always keep the firearm pointed in a safe direction.
2. Engage the safety mechanism in the "ON" or "Safe" position. The red band will NOT be visible.
3. Completely unload the chamber and magazine. (See "To Unload the Firearm," page 14).
4. With the bolt locked open, visually check the chamber, ejection port, and magazine making sure the shotgun is completely unloaded.

- Remove the magazine cap by turning it counterclockwise.
- Remove the fore-end from the magazine tube by sliding it forward.
- While holding the barrel above the barrel ring, pull the barrel from the receiver. See Picture 18.

### To Remove the Gas Pistons:

- With the barrel removed, remove both gas compensation plug assemblies using a punch (or similar tool), or open end wrench or adjustable wrench turning counterclockwise. See Picture 19.

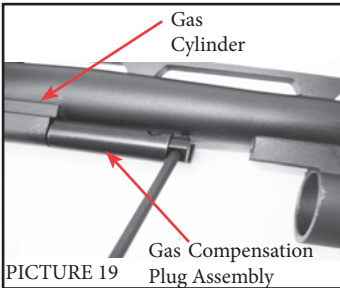

- Remove the gas pistons from the muzzle end of the gas block. See Picture 20.

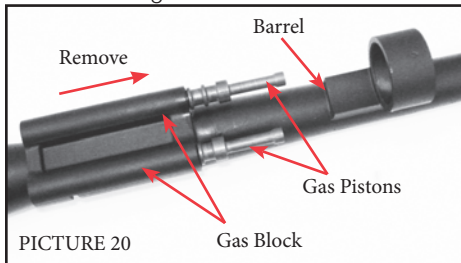

### To Remove the Trigger Plate Assembly:

- While holding the operating handle, push the bolt release then slowly let the bolt move forward.
- Tap out both trigger plate pins with a drive punch. See Picture 21.

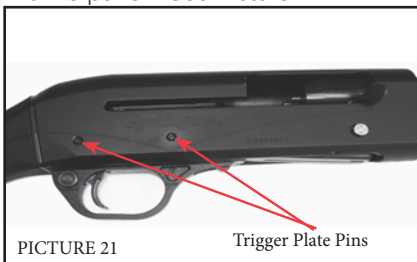

- Remove the trigger plate from the receiver by pulling the trigger plate downward from the receiver. See Picture 22.

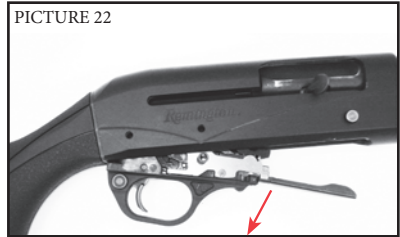

### To Remove the Bolt Assembly:

- Release the bolt assembly by pushing the bolt release button. See Picture 10.
- Allow the bolt assembly to come to forwardmost position in the receiver where the operating handle is resting on the front edge of the ejection port. In this position the operating handle will be aligned with the undercut in the front lower corner of the ejection port. See Pictures 23 and 23A.

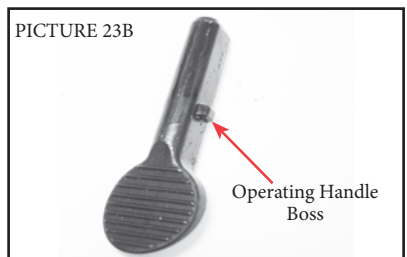
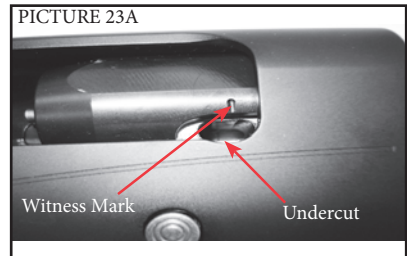
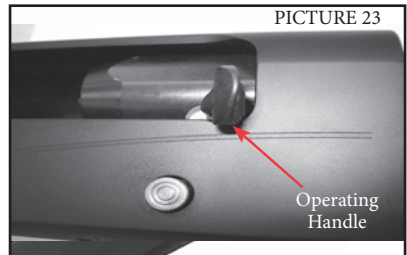

15. If the bolt gets stuck in an intermediate position between its rearmost and forward most position apply light and rearward pressure to the operating handle to release it from this intermediate position. Continue with this light pressure to allow the bolt to come forward.
16. Remove the operating handle by pulling it away from the bolt.
17. Remove the bolt assembly from the receiver by sliding it forward.

### To Disassemble the Bolt Assembly:

**WARNING!** Use extreme care when removing the firing pin and firing pin retainer, as the firing pin is under compression. Wear eye protection to avoid serious personal injury.

18. Hold the ejector rod and firing pin in place with one hand and remove the two firing pin retaining pins with the other hand. Slowly release the spring tension on the firing pin and ejector rod and remove the firing pin, firing pin spring, ejector rod and ejector rod spring. See Pictures 24 and 24A.

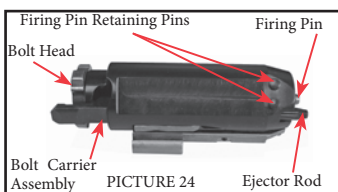

19. Remove the bolt carrier assembly from the bolt body by pulling the bolt carrier assembly down.
20. Remove the bolt carrier blocker and shell support from the bolt body. See Picture 24B.

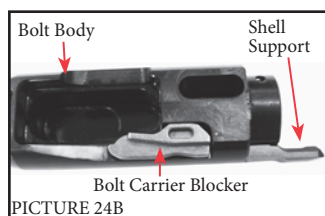

### To Clean the Barrel:

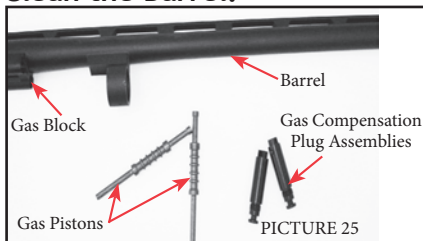

1. Use the instructions and equipment provided in a quality cleaning kit such as a Remington Cleaning Kit. For recommendations, see your dealer or a Remington Authorized Service Center.
2. Saturate a cleaning patch with Remington Brite Bore® or equivalent.
3. Attach the patch to a cleaning rod tip.
4. Pass the patch through the barrel from the chamber end to the muzzle several times, removing loose residue and fouling.
5. Select the correct gauge cleaning brush and attach to the cleaning rod.
6. Spray the bore brush with Brite Bore.
7. Push the cleaning rod through the barrel several times.
8. Remove the brush from the rod and attach a tip with a cleaning patch.
9. Push the cleaning patch through the barrel.
10. Repeat several times using a new cleaning patch each time until the patch is removed from the barrel with out fouling residue.
11. Remove all shooting residue from the barrel's locking notches using a cleaning patch. See Picture 26.

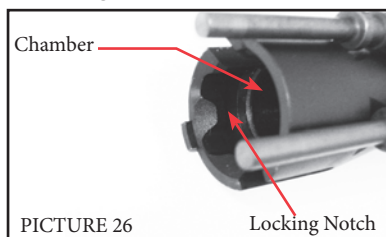

12. Spray the gas block, gas compensation plug assemblies, and gas pistons with Brite Bore or equivalent cleaner and brush to remove shooting residue.
13. Use a .40 cal bore brush and cleaner to thoroughly scrub the inside of the gas cylinders in the gas block.

14. To dry, use compressed air or allow to air dry.
15. Push a clean patch saturated with Rem Oil or equivalent through the barrel including the gas block.
16. Push a clean dry patch through the barrel to remove excess lubricant.
17. Apply a light application of Rem Oil to the outside of the barrel and gas pistons, with a soft clean cloth.
18. Remove all excess lubricant with a clean dry patch.

**WARNING!** After cleaning, make sure the barrel and chamber are free of obstructions, see page 10, "To Check the Barrel for Obstructions." Discharging a firearm with an obstruction may lead to property damage, personal injury and/or death.

### To Clean the Choke Tube:

1. Remove the choke tube from the barrel. See "To Change the Choke Tube," page 14.
2. Brush the choke tube, including the threads with Brite Bore or equivalent until clean.
3. Brush the mating barrel choke tube threads with Brite Bore or equivalent until clean.
4. Push a clean patch through the choke tube.
5. Repeat several times using a new cleaning patch each time until all residue is removed.
6. Wipe clean and let dry.
7. When dry, apply a light application of Rem Oil. Include the mounting threads and mating threads in the barrel.
8. To install the choke tube into the barrel see, "To Change the Choke Tube," on page 14.

### To Clean the Bolt Assembly:

1. Spray the bolt assembly components using Rem Action Cleaner or equivalent. Brush if necessary to remove all residue.
2. To dry, use compressed air or allow to air dry.
3. Apply a light coating of Rem Oil to bolt assembly.

4. Remove all excess lubricant with a clean dry patch.
5. Lightly apply grease to cam pin. See Picture 26A.

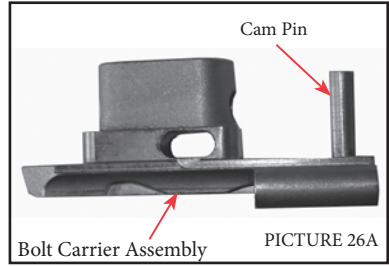

### To Clean the Trigger Plate Assembly:

**WARNING:** Clean the Trigger Plate Assembly as a unit. Do not disassemble. Failure to reassemble properly may result in serious personal injury and/or death.

1. Thoroughly spray Rem Action Cleaner inside the trigger plate assembly where specified in Picture 27.

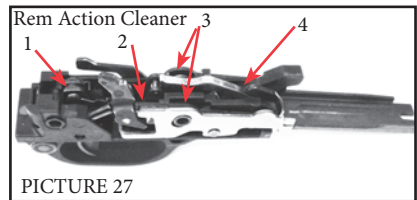

2. Thoroughly dry the trigger plate assembly either by compressed air or let air dry.
3. Disengage the safety mechanism by moving the safety button to the left.
4. With your thumb on hammer and the safety disengaged, pull the trigger rearward and release. See Picture 28. Repeat multiple times, ensure the trigger returns completely to the forward position each time. Repeat steps 1 thru 4 if the trigger does not fully return.

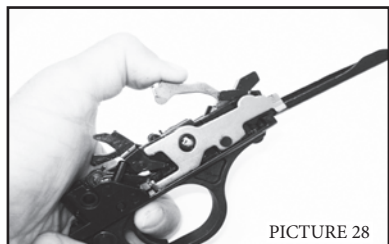

**WARNING!** If the trigger does not fully return to the forward position each time it is released, then your firearm is **NOT** in a safe operating condition and it must **NOT** be used until you have had it repaired by a Remington Authorized Repair Center. The use of a firearm that is not in a safe operating condition may result in serious personal injury and/or death.

5. With the hammer fully rearward in the cocked position; engage the safety mechanism, multiple times, in the "ON" or "Safe" position by moving the safety button fully to the shooter's right. The red band will NOT be visible.
6. The safety button must travel fully and freely to the "ON" or "Safe" position. The safety should *NOT* remain in a position between the "Safe" and "Fire" position.
7. If the safety mechanism does not freely return to the full "Safe" or "Fire" position, repeat steps 1 and 2.
8. If the safety mechanism does not freely return to the "Safe" or "Fire" position after repeating operations 1 and 2, return the firearm to a Remington Authorized Repair Center for an inspection of the safety and trigger assembly.

**WARNING!** If the safety mechanism does not freely return to the full "Safe" or "Fire" position; the firearm is **NOT** safe to use. The use of a firearm that is not in a safe operating condition may result in serious personal injury and/or death. Return the firearm to the factory or to a Remington Authorized Repair Center.

9. Apply a light application of Rem Oil to the areas specified in Picture 27.

### To Clean the Receiver Assembly:

1. Remove the action springs and guide rods. See Picture 29.
2. Thoroughly spray and brush all components inside the receiver using Rem Action Cleaner or equivalent.
3. Air dry or use compressed air to thoroughly dry the receiver assembly.
4. Spray the outside of the magazine tube with Rem Action Cleaner and wipe clean. Scrub, if necessary, with steel wool.
5. Wipe with a clean cloth and air dry or use compressed air to thoroughly dry the magazine tube.

6. Apply a light application of Rem Oil to the inside and outside of the receiver. Specifically ensure that there is lubrication on the receiver insert and the area to the rear of the receiver insert on the inside wall of the receiver. Lubrication must always be present on these surfaces for proper function of this firearm. See Picture 28a

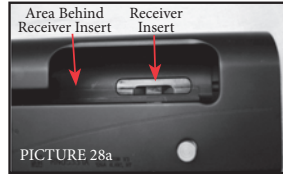

7. Remove all excess lubricant with a clean dry cloth.

**Note:** While your firearm has been designed and manufactured to provide improved corrosion protection, only proper care will keep your firearm in a good operating condition and maintain its appearance. After extensive use, the protective coating on plated parts may become worn sufficiently to reduce the corrosion protection. Such worn parts should be replaced to assure the integrity of the corrosion protection. Remington recommends you have your firearm serviced periodically by a Remington Authorized Repair Center ensuring the proper function and replacement of any worn parts. For firearm service see: "Repair Service," on page 30.

### To Reassemble the Bolt Assembly:

1. Insert the bolt carrier blocker in the bolt body. See picture 24B on page 18 for orientation of the bolt carrier blocker. Install with the assembly boss inserted into the hole in the bolt body.
2. Insert the bolt carrier assembly. See Picture 24.
3. Insert shell support into its pocket on the bolt body. See Picture 24B.
4. Install the firing pin spring on the firing pin, then insert into the bolt body.
5. Install the ejector rod spring over the ejector rod, then insert into bolt body.
6. While holding the ejector rod and firing pin forward, properly align the assembly notches in both and insert the firing pin retaining pins into the bolt body.

## To Reassemble the Gas Block:

1. Insert the gas pistons, small end first, into the top of the gas cylinders. See Picture 20.
2. Secure each piston in the gas cylinder by inserting the gas compensation plug assemblies in the top of the gas cylinders. Tighten the gas plugs into the gas cylinder by turning clockwise. Torque plugs to 100 in-lbs. If a torque wrench is unavailable, tighten to hand tight and then give a quick and firm pull or yank on the tool to securely tighten the plugs. See Picture 19.

## To Reassemble the Firearm:

**CAUTION! Always wear eye protection when handling, disassembling and reassembling the firearm. Not wearing eye protection may lead to personal injury.**

1. Place the action springs over the guide rods before assembly. See Picture 29.
2. Insert the guide rods head first with action springs into the rail slots on both sides of the receiver. See Picture 29.

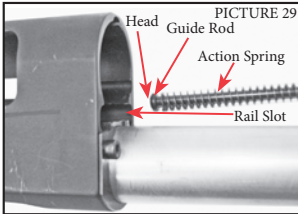

3. Ensure that the head of the guide rod sits entirely in the hole at the bottom of the rail slot before assembling the bolt.
4. Insert the bolt assembly into the front of the receiver. The bolt carrier will rest on the front of the action springs as you slide it into the receiver.
5. With your left hand hold the front of the bolt carrier down until it is flush with the front of the receiver (do not push on the bolt head or bolt body for this assembly step). See Picture 30.

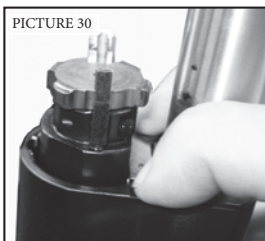

6. While viewing the right side of the bolt assembly, align the witness mark on the bolt body with the center of the bolt handle slot in the bolt carrier and the undercut in the front of the ejection port on the receiver. With these features aligned, insert the operating handle into the bolt carrier until it is fully engaged. See Pictures 23A and 23B.

**NOTE:** The operating handle can only be installed and removed with the bolt assembly in this location. See Picture 23.

7. To install the trigger plate assembly, ensure the hammer is in the cocked position. If the hammer is not in the cocked position, rotate the hammer fully rearward until it engages the sear roller. See Picture 31.

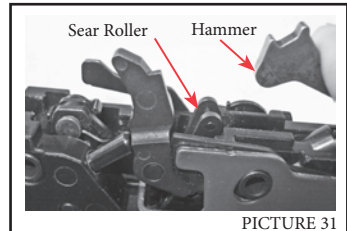

8. Install the trigger plate assembly into the receiver by inserting it into the main slot in the receiver and aligning the trigger plate pin holes in the trigger plate and receiver. See Picture 32.

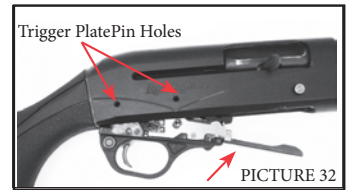

9. Attach the trigger plate assembly to the receiver by replacing the trigger plate pins so they are flush with both sides of the receiver.
10. Open the bolt by pulling the operating handle fully rearward until the bolt assembly locks in the open position.
11. Insert the barrel into the receiver while aligning the barrel ring over the magazine tube. See Picture 8.
12. Slide the fore-end over the magazine tube.
13. Place the magazine cap on the end of the magazine tube. Tighten by turning clockwise until hand-tight.

## To Function Test the Firearm:

When the firearm is fully reassembled, a short function test should be conducted to ensure proper operation before loading or discharging the firearm. If the firearm does not function as described in any part of the Function Test, then the firearm should be reassembled and function tested again. Do **NOT** discharge the shotgun, if the firearm fails the Function Test again. See page 30, to find instructions on how to obtain Repair Services.

**WARNING!** Completely unload the firearm before Function Testing. Look into the ejection port and visually check the chamber and magazine to make sure there are no cartridges in the firearm. Always wear eye protection when handling the firearm. Function testing with a loaded firearm or without eye protection may lead to property damage, personal injury and/or death.

1. Always keep the firearm pointed in a safe direction throughout the Function Testing process.
2. Engage the safety mechanism in the "ON" or "Safe" position by moving the safety button fully to the shooter's right. The red band will NOT be visible.
3. Make sure that the magazine tube is empty. See Page 14.
4. Pull the operating handle fully rearward to lock the bolt in the open position.
5. With the bolt locked open, visually check the chamber, loading port, and magazine making sure the firearm is completely unloaded. If the chamber is not unloaded, see page 14, "To Unload the Firearm."
6. Make sure the barrel and chamber are free of obstructions, see page 10, "To Check the Barrel for Obstructions."
7. Close the action by pressing the bolt release. The bolt should slide forward and lock into the firing position. The hammer should NOT release.

**WARNING!** If the hammer does NOT remain cocked when the action is smartly closed, the firearm is NOT safe to use. Using the firearm in this condition may lead to firearm malfunctions which could result in serious personal injury or death.

See page 30, to find instructions on how to obtain Repair Services.

8. With the safety mechanism engaged, attempt to pull the trigger fully rearward. The trigger should not move and the hammer should NOT release.

**WARNING!** If safety allows trigger to release hammer your firearm is not in a safe operating condition and it must NOT be used until you have it inspected and the problem corrected by a Remington Authorized Repair Center. See page 30, to find instructions on how to obtain Repair Services. Using the firearm in this condition may lead to firearm malfunctions which could result in serious personal injury and/or death.

9. To check if the hammer released in step 7 or 8, disengage the safety mechanism by moving the safety button to the "OFF" or "Fire" position. The red band will be visible. Pull the trigger fully rearward. The hammer should release.
10. After the trigger is pulled and released, verify the trigger returns to the fully forward position.

**WARNING!** If the trigger does not fully return to the forward position each time it is released, your firearm is NOT in a safe operating condition and it must NOT be used until you have it inspected and the problem corrected by a Remington Authorized Repair Center. See page 30, to find instructions on how to obtain Repair Services. Using the firearm in this condition may lead to firearm malfunctions which could result in serious personal injury and/or death.

11. Open the action by pulling the operating handle fully rearward, locking the bolt in the open position.
12. Close the action by pressing the bolt release.
13. Check the trigger operation by pulling the trigger fully rearward. Hold the trigger rearward. Do not release the trigger.
14. While holding the trigger rearward, pull the operating handle fully rearward to lock the bolt open.
15. While continuing to hold the trigger rearward, push the bolt release button. The hammer should not release.

16. To check if the hammer released in steps 14 or 15, remove your finger from the trigger. With the trigger fully forward, pull the trigger fully rearward. The hammer should release and fall forward.

**WARNING!** If the hammer does NOT remain cocked during cycling of the action and while the trigger is continuously pulled, the firearm is NOT safe to use. Using the firearm in this condition may lead to firearm malfunctions which could result in serious personal injury and/or death. See page 30, to find instructions on how to obtain Repair Services.

17. Repeat steps 7 thru 15 multiple times.
18. Engage the safety mechanism in the "ON" or "Safe" position. The red band will NOT be visible.
19. With the Safety in the "ON" or "Safe" position, bolt locked open, and the chamber and magazine completely unloaded, verify the choke tube is present, tight, and secure.

**NOTE:** Never discharge your shotgun without a choke tube properly installed, as property damage may occur.

---

**WARNING!** Incorrectly assembling the firearm or assembling with modified parts can result in damage to your firearm, personal injury or death to you or others. Remington recommends all service and replacement of components be performed by a Remington Authorized Repair Center. If a repair or component replacement was not completed by a Remington Authorized Repair Center we recommend that you have your firearm checked by an Authorized Repair Center. See page 30, for instructions for repair services

The firearm owner and user must accept full responsibility for the correct reassembly and functioning of the firearm after disassembly or replacement of parts.





# V3™

## Autoloading Shotgun

Exploded View

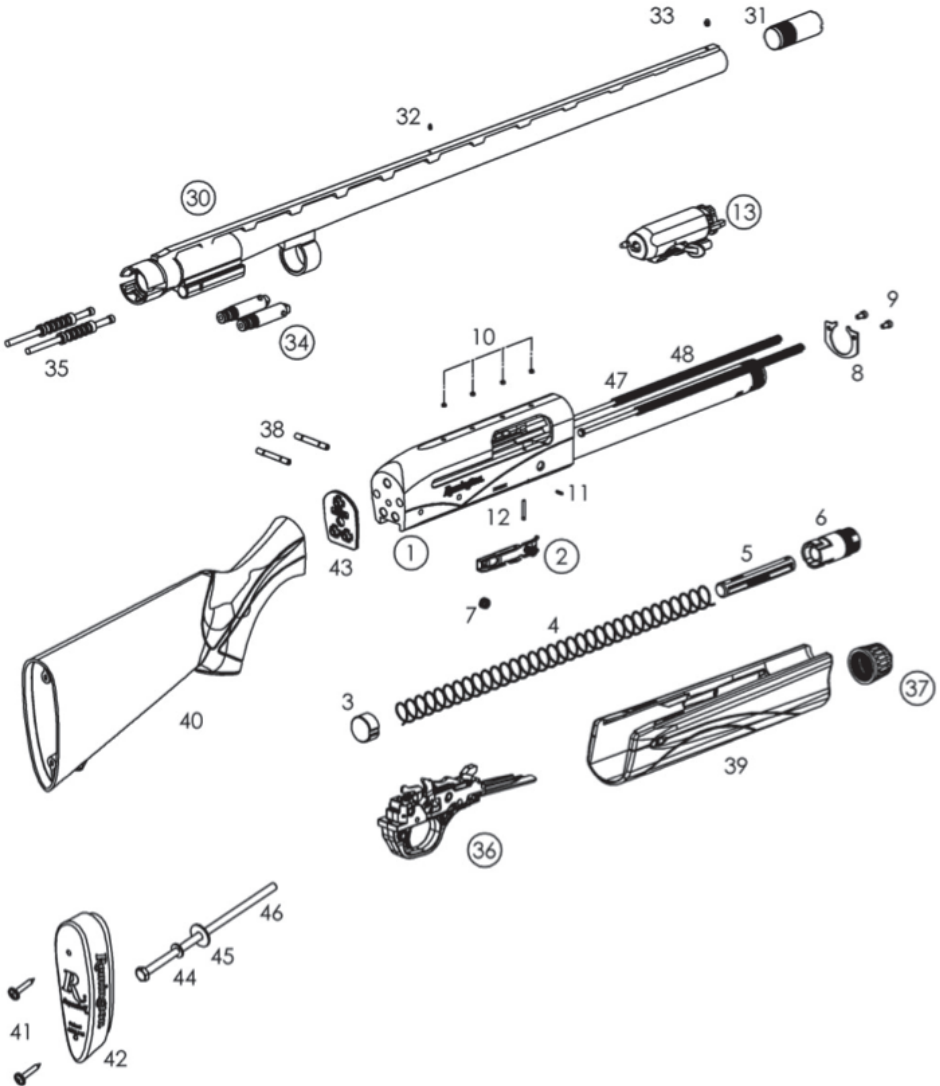

**Autoloading Shotgun****Parts List**

Note: Parts are subject to change without notice.

ITEM NO.	PART NAME	ITEM NO.	PART NAME
1	Receiver Assembly	43	Stock Shim
2	Feed Latch Assembly	44	Stock Attachment Lock Washer
3	Magazine Follower	45	Stock Bolt Washer
4	Magazine Spring	46	Stock Attachment Bolt
5	Magazine Plug	47	Guide Rod (2)
6	Magazine Spring Retainer	48	Action Spring (2)
7	Latch Spring	49	*TPA Lock
8	Piston Stop Plate		
9	Piston Stop Plate Screw (2)		
10	Receiver Plug Screw (4)		
11	Latch Pivot Pin Retaining Pin		
12	Feed Latch Pivot Pin		
13	Bolt Assembly		
30	Vent Rib Barrel Assembly		
31	Choke Tube		
32	Middle Sight		
33	Bead Front Sight		
34	Gas Compensation Plug Assembly (2)		
35	Gas Piston (2)		
36	Trigger Plate Assembly		
37	Magazine Cap Swivel Assembly		
38	Trigger Plate Pin (2)		
39	Fore End		
40	Stock Assembly		
41	Recoil Pad Screw (2)		
42	Recoil Pad		

Schematic is provided for part identification only and should not be used as a guide to assemble the firearm.

\* Not Shown

Parts subject to change without notice

## Autoloading Shotgun

### Bolt and Trigger Plate Assembly Exploded View

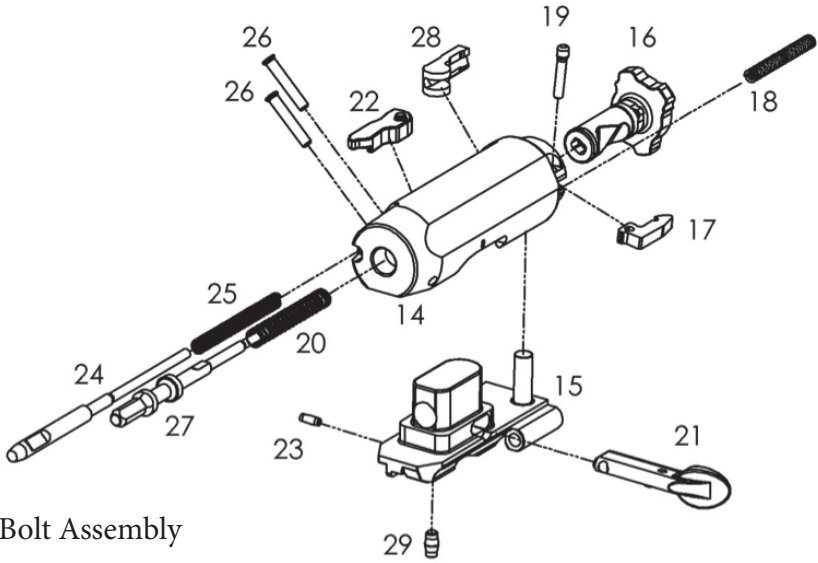

13 - Bolt Assembly

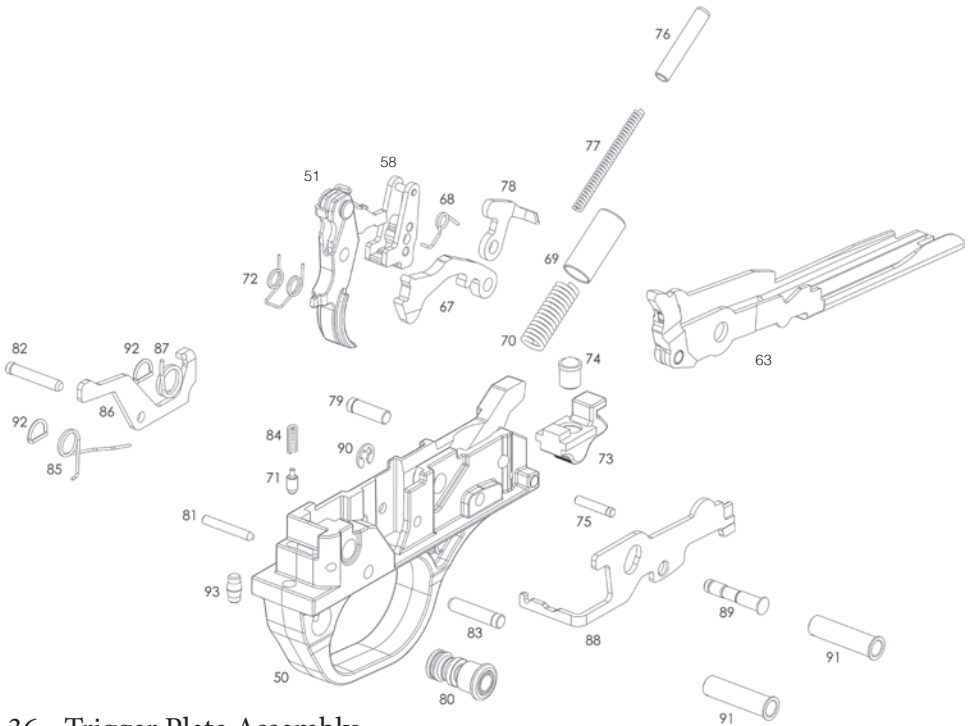

36 - Trigger Plate Assembly

## Autoloading Shotgun

### Bolt and Trigger Plate Assembly Parts List

Note: Parts are subject to change without notice.

#### 13 - Bolt Assembly

ITEM NO.	PART NAME	ITEM NO.	PART NAME
14	Bolt Body	22	Bolt Carrier Blocker
15	Bolt Carrier Assembly	23	Bolt Handle Buffer Retaining Pin
16	Bolt Head	24	Ejector Rod
17	Extractor	25	Ejector Spring
18	Extractor Spring	26	Ejector Retaining Pin (2)
19	Extractor Pivot Pin	27	Firing Pin
20	Firing Pin Spring	28	Shell Support
21	Bolt Handle	29	Trigger Plate Buffer

#### 36 - Trigger Plate Assembly

ITEM NO.	PART NAME	ITEM NO.	PART NAME
50	Trigger Plate	76	Carrier Dog Plunger
51	Trigger Assembly	77	Carrier Dog Spring
52	*Trigger	78	Latch Release Lever
53	*Trigger Pin	79	Hammer Pivot Pin
54	*Trigger Spring	73	Magazine Cutoff
55	*Trigger Stop	74	Magazine Cutoff Detent
56	*Connector	75	Magazine Cutoff Retaining Pin
57	*Connector Bushing	76	Carrier Dog Plunger
58	Sear Assembly	77	Carrier Dog Spring
59	*Sear	78	Latch Release Lever
60	*Sear Side Plate (2)	79	Hammer Pivot Pin
61	*Sear Roller	80	Safety Button
62	*Sear Pin (2)	81	Safety Button Retaining pin
63	Carrier Assembly	82	Sear Pivot Pin
64	Carrier	83	Trigger Pivot Tube
65	Carrier Dog	84	Safety Detent Spring
66	Carrier Dog Pivot Spring	85	Latch Release Spring
67	Hammer	86	Carrier Lever
68	Sear Spring	87	Carrier Lever Spring
69	Hammer Plunger	88	Latch Release
70	Hammer Spring	89	Latch Release Pivot Pin
71	Safety Detent Plunger	90	Latch release Pivot Pin Retaining Ring
72	Trigger Return Spring	91	Carrier Pivot Tube (2)
73	Magazine Cutoff	92	Trigger Plate Detent Spring (2)
74	Magazine Cutoff Detent	93	Trigger Plate Buffer
75	Magazine Cutoff Retaining Pin		

Schematic is provided for part identification only and should not be used as a guide to assemble the firearm. Parts subject to change without notice \* Not Shown

## How to Obtain Parts and Service From Remington Arms Company, LLC.

### To Order Parts:

To order parts please visit Remington's web site at: [www.remingtonpartsstore.com](http://www.remingtonpartsstore.com) or call 1-800-243-9700. For additional information on service enhancements, up-grades, repair, additional barrels, and specialty parts visit [www.remington.com](http://www.remington.com). To place an order or for additional information on service enhancements, up grades, and additional barrels, please call us toll free consumer service number, 1-800-243-9700, Mon.-Fri., 9:00 AM - 5:00 PM Eastern time.

1. Fax completed order form (from the web site) to 1-336-548-7801.
2. To order by phone without the order form call 1-800-243-9700.

### Please have the following information ready before you call.

- Firearm model and serial number.
- Part description and quantity. Part descriptions can be found on the parts listing pages 26 through 29 in this manual.
- Your complete mailing address (P.O. Box and Street Address) including zip code, telephone number and e-mail address.
- Method of payment: MasterCard, Visa, Amex or Discover card number and expiration date. A quote may be made to you over the phone. (Sorry, no C.O.D.s.)

**WARNING! Use only Remington parts in Remington's firearms. Failure to follow these instructions may lead to property damage, personal injury and/or death.**

**Note:** Owner's manuals/instruction books may be requested via our web site at: [www.remington.com](http://www.remington.com) or by calling 1-800-243-9700.

### Repair Services:

If there is a defect with your Remington firearm that (i) you believe is, or should be, covered by the Warranty, (ii) you would like Remington to address at your cost and expense, or (iii) you would otherwise like to discuss with Remington, please contact Remington Consumer Services at 1-800-243-9700, Mon.- Fri. 9:00 AM – 5:00 PM. Please do not send your firearm or other item to Remington without first (a) calling this number, (b) receiving instructions from the Remington representative, and (c) obtaining a Service Request document containing your Service Repair Number. With regards to the Service Request document, Remington will either e-mail this document to you or, if you do not have an e-mail address, Remington will mail it to you. Please be sure to store your Service Request document in your records so that it is both safe and accessible. Finally, to the extent you seek Warranty coverage, please review the Warranty for your Remington firearm and note that you may void your Warranty by taking action without first contacting Remington.

All rights to this instruction manual are reserved. The information in this document is subject to change without notice. Remington reserves the right to change the content herein without the obligation to notify any person or organization of such changes.

Remington, V3, Rem, BriteBore, and the color green are trademarks of RA Brands, L.L.C. and may not be used in any way without the express written consent of Remington. All other trademarks used herein remain the exclusive property of their respective owners. Nothing contained in this manual should be construed as granting, by implication or otherwise, any license to trademarks displayed herein. Misuse of any trademarks or any content of this manual is strictly prohibited. Remington shall aggressively enforce its intellectual property rights to the fullest extent of the law.

# Firearm Owner's Record

Model: \_\_\_\_\_

Serial # \_\_\_\_\_

Date Purchased: \_\_\_\_\_

Purchased From: \_\_\_\_\_

Price Paid: \_\_\_\_\_

Remember to complete and return the Firearm Warranty Registration Card in order to obtain full benefit of your Limited Two Year Firearm Warranty.

## **A WORD ON THE MAINTENANCE AND CARE OF YOUR REMINGTON FIREARM**

### **Don't Alter or Modify Your Firearm and Have it Serviced Regularly.**

Your firearm has been designed to operate according to certain factory specifications. You'll jeopardize your safety and that of others around you by attempting to alter its trigger, mechanical safety or other mechanisms. Never alter or modify your firearm in any way.

Like any mechanical device, a firearm is subject to wear. It must be maintained and periodically serviced to assure optimum safety and performance. Only a qualified service facility should service, repair or modify your Remington firearm. Remington recommends that you have your firearm professionally serviced annually. You should

also have your firearm professionally serviced after prolonged storage, or if there is ever any question pertaining to the proper functioning characteristics of your firearm.

Proper cleaning and lubrication are also important to firearm maintenance and are necessary to assure accuracy, safety, and reliability. Before cleaning, always make sure that your firearm is completely unloaded. And always clean the barrel from the chamber end to the muzzle when possible.

### **Firearm Sale or Transfer:**

If your firearm has been adjusted or changed in any way and you intend to sell or otherwise transfer possession of your firearm, you must: 1) provide a complete service record, (2) warn the purchaser or recipient of your firearm that it has been adjusted or modified, and (3) give the purchaser or recipient this owner's manual for review and reference. If you do not wish to sell or transfer your firearm in an adjusted condition (recommended), return it to a Remington Authorized Repair Center for restoration of your firearm to the original factory conditions. Do Not attempt to restore the firearm to factory conditions yourself.

**WARNING! NEVER alter or modify any part of the firearm. Improper alterations can make the firearm unsafe and result in personal injury or death to you or others.**

This firearm should not be sold where prohibited by federal, state or local laws.

MODEL V3™  
Autoloading Shotguns

*Remington*® AND *R*®

ARE LICENSED TRADEMARKS OWNED BY AMMUNITION OPERATIONS, LLC AND ARE USED UNDER LICENSE AND AMMUNITION OPERATIONS, LLC IS NOT A MANUFACTURER, ENDORSER, OR SELLER OF ANY PRODUCTS MANUFACTURED OR SOLD BY REMARMS, LLC